

# The 3<sup>rd</sup> Annual Chapter Installation of Officers & Induction of New Members



**FY 2013-2014**

**AUGUST 24, 2013, SATURDAY  
GLENDALE, CALIFORNIA, USA**



# national anthems



## *Star-Spangled Banner* (abridged version)

O! say can you see  
By the dawn's early light  
What so proudly we hailed  
At the twilight's last gleaming  
Whose broad stripes  
And bright stars through  
the perilous light  
O'er the ramparts we watched  
Were so gallantly streaming  
And the rocket's red glare  
The bombs bursting in the air  
Gave proof through the night  
That our flag was still there  
O! say does that star-spangled  
Banner yet wave  
O'er the land of the free  
And the home of the brave

## *Lupang Hinirang*

Bayang magiliw, perlas ng silanganan  
Alab ng puso sa dibdib mo'y buhay  
Lupang hinirang, duyan ka ng magiting  
Sa manlulupig hindi ka pasisiil  
Sa dagat at bundok, sa simoy at  
Sa langit mong bughaw  
May dilag at tula at awit  
Sa paglayang minamahal  
Ang kislap ng watawat mo'y  
Tagumpay na nagniningning  
Ang bituin at araw niya  
Kailan pa ma'y di magdidilim  
Lupa ng araw ng luwalhati't pagsinta  
Buhay ay langit sa piling mo  
Aming ligaya na 'pag may  
mang-aapi  
Ang mamatay nang dahil sa iyo



*United Architects of the Philippines  
Southern California Chapter, Inc.*

I shall work with this virtuous commitment: to exercise to the utmost my duty to myself, my country and my God.

I shall uphold the ideals, follow the norms of conduct of a noble profession, and endlessly endeavor to protect and further its just ends.

I shall abide by the laws, rules, legal orders, statutory policies and measures of my country; the Code of Ethical Conduct and the Standards of Professional Practice; and the Articles of Incorporation and By-laws of the United Architects of the Philippines Southern California Chapter.

I shall humbly seek success not through the measure of solicited personal publicity, but by industrious, meaningful application to my work, and strive to merit a reputation for quality of service and for equitable dealings.

I shall ask for fair remuneration for my professional services from my Client, and hold his/her interest over and above my own.

I shall disclose, whenever required, any private business investments or ventures that may tend to create a conflict of interest, and ensure that such conflict does neither to compromise the legitimate interest of my Clients nor interfere with my duty to render impartial judgment.

I shall exercise my professional prerogatives always with the highest level of integrity.

I shall inspire, by my behavior, the loyalty of my associates and subordinates, and take upon me the mentorship of the aspirants to the profession.

I shall confine my criticisms and praises within constructive and inspirational limits, and never resort to these means to promote any malicious motives.

I shall dedicate myself to the pursuit of creative endeavor towards the goal of enlightened Art and Science, generously sharing the benefits of my research, experience and expertise.

I shall consecrate myself to the highest standard of professionalism, integrity, and competence to the public, to the Client, to the contractor, to the manufacturers, dealers and agents, and to colleagues and subordinates who are the direct and indirect users and beneficiaries of my architectural service.

**Architect's credo**





# Program of events

## *Registration / Assembly*

### PART I OPENING CEREMONIES

- |                        |                               |  |
|------------------------|-------------------------------|--|
| 1.1                    | Invocation                    | David William B. Labrado, UAP<br>Charter Member and Director of<br>Internal and External Affairs 2012-2013     |
| 1.2                    | National Anthems              | Vida R. Ilao, UAP<br>Corporate Member  |
| 1.3                    | UAP March                     |  |
| 1.4                    | Architect's Credo             | Leilanie Pekson – Panyawai, UAP<br>Charter Member and Vice - President<br>Programs and Development - 2011-2012 |
| 1.5                    | Welcome Remarks               | Edith M. Fuentes, UAP<br>Corporate Member, Civic Leader  |
| <i>Luncheon Buffet</i> |                               |  |
| 1.6                    | Video Presentation            | Timely Prefinished Door Frames   |
| 1.7                    | Presentation of Certificates: | Joven G. Joaquin, Jr. , UAP LEED-AP<br>Charter Member and<br>President 2012 - 2013                             |
|                        |                               | Emerito D. Maulion, UAP<br>Charter Member and<br>Ex-Officio President 2011-2012                                |

Certificate of Appreciation - Timely Prefinished Door Frames  
Certificate of Appreciation – Los Angeles City Mayor Eric Garcetti  
Certificate of Appreciation - Glendale City Mayor Dave Weaver  
Certificate of Appreciation - CG Maria Hellen B. De La Vega





**PART II INTRODUCTION OF CHAPTER OFFICERS**

- 2.1 Presentation of Chapter Officers Teofilo R. Cotangco, UAP  
Charter Member and Director of  
Commission On Election 2013 - 2014
- 2.2 Charging and Installation of Officers  
and Oathtaking of Chapter Officers Rozanno C. Rosal, FUAP  
UAP National President 2013 - 2014
- 2.3 Presentation of Chapter Gavel Emerito D. Maulion, UAP
- 2.4 Message from the Chapter President Joven G. Joaquin, Jr., UAP LEED AP

**PART III INTRODUCTION OF MEMBERS**

- 3.1 Presentation of New Members Teofilo R. Cotangco, UAP
- 3.2 Charging of New Members and  
Oathtaking of Chapter Members Joven G. Joaquin, Jr., UAP
- 3.3 Pinning Rites Spouse and/or Guests

**PART IV CLOSING CEREMONIES**

- 4.1 Introduction of National President Emerito D. Maulion, UAP
- 4.2 Message of National President Rozanno C. Rosal, FUAP
- 4.3 Certificate of Recognition Award  
to Rozanno Cruz Rosal , FUAP ConsuL General Ma. Hellen B. De La Vega,  
Mayor of Glendale Dave Weaver  
Joven G. Joaquin, Jr.
- 4.4 Closing Remarks Cezar V. Obnial. AIA UAP  
Corporate Member and Vice-President  
Programs and Development, 2013 - 2014
- 4.5 Acknowledgement / Adjournment Edith M. Fuentes. UAP

*Pictorial / Fellowship / Raffles*

**Program of events**







## UNITED ARCHITECTS OF THE PHILIPPINES

The Integrated and Accredited Professional Organization of Architects (IAPOA)



# messages

It is with deepest honor and privilege that I congratulate the outgoing and the incoming officers of UAP Southern California Chapter on the occasion of your *Chapter Turnover and Induction Ceremony for the Fiscal Year 2013-2014 on August 24, 2013.*

Your mutual commitment to the organization and with your individual capabilities as exceptional leaders will be the greatest attributes that would bring your chapter to excellence and at the same time provide the entire organization the boost of encouragement to move on despite the many challenges we face.

Through the years, UAP Southern California Chapter has been in the forefront because of its consistent hard work and dedication of your officers and members.

Today, you are again called to give assurance for the continuity of that prestigious legacy. The challenges are indeed formidable however I am certain that you can easily achieve them with your courage and dynamism for another Fiscal Year.

Remember that at UAP, change continues to be the norm. Nothing excites me more than transformational change and new challenges. Our challenge, as we look to the future, includes sustaining the vision of UAP as a prime organization of architects in the Philippines, completing the transformation, ensuring the future and preserving the legacy.

In this, I would like to state that this event is a momentous occasion at this place and time -- a manifestation of transformational change. And as we inherited the great works and achievements of the past administrations, I enjoin you to support the present national leadership in its continuing quest for greatness and let us make the most of the opportunities that abound and face the challenges ahead through our corporate thrusts: **PROTECT THE PROFESSION, PROMOTE THE PRACTICE AND SERVE THE MEMBERS!**

Maraming salamat sa inyong tiwala at suporta! Mabuhay ang UAP!

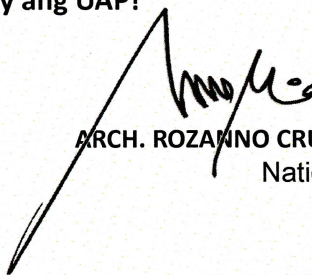
  
ARCH. ROZANNO CRUZ ROSAL, FUAP  
National President



CONSULATE GENERAL



OF THE PHILIPPINES

LOS ANGELES

It is with great pleasure that I extend my warmest felicitations to the officers and members of the United Architects of the Philippines, Southern California (UAPSOCAL) Chapter as they hold the Installation of their Officers and Induction of New Members.



Allow me to commend the Association for its presence in the highly competitive construction industry in Southern California.

We appreciate your commitment to the business and profession of architecture as shown in your continuing training and education programs both in the United States and the Philippines.

Let me also congratulate your new set of officers. I am confident that through your talent, energy and dedication, and the support of the Filipino community, the programs, aspirations and the future of the Association would be secure, auspicious and bright.

*Mabuhay po kayo!*

MARIA HELLEN BARBER DE LA VEGA  
Consul General

CITY OF GLENDALE



CALIFORNIA

Office of the Mayor

Greetings,

Magandang araw po sa inyong lahat!



I would like to offer my greetings on behalf of the entire City Council of Glendale to the United Architects of the Philippines on your upcoming event in Glendale. As an engineer myself, I truly support the splendid work of the talented architects of all countries. I appreciate the fact that the Filipino architects are working together to further advance the art of the architecture and the Filipino's role in that effort.

I would also like to send my personal greetings to the National President of the United Architects in the Philippines, Mr. Sonny Rosal and hope he enjoys his stay here.

I am sure you will have a great luncheon and look forward to attending with my Filipina wife, Erlinda Casaxola Deverturda Weaver.

Mabuhay!

DAVE WEAVER  
Mayor of Glendale  
Civil Engineer

messages



# messages



My Warmest greetings to the officers and members of UAP Southern California Chapter.



Being our District Director, I encourage you to participate in UAP national Thrusts, "Protect the Profession, Promote the Practice and Serve the Members".

Also, I would like you to promote our Corporate Social Responsibility (CSR) statement of "Safe Accessible and Sustainable Societies".

The UAP National Board and District A-5 will support the plans and programs of your chapter. To all members, take vigorous and meaningful participation in the activities of your chapter. Once again CONGRATULATIONS!

Mabuhay ang ARKITEKTONG PILIPINO!



*J. Vinta*  
JUANITO A. VINTA, UAP  
District Director A-5

An architect is born to visualize and fill in the spaces for others to know they exist. In an abstract world, reality is known. An organization is composed of people sharing the same vision, the same passion, and the same motivation.

As incoming officers take the help from the outgoing, the helm of leadership professionally passed on. Genius is personal, decided by fate, but it expresses itself by means of system. There is no work of art without system. Words of Le Corbusier will describe how the system works, and we, the architects must stand firm.

UAP is growing stronger. So must also be the architect. The contemporary world offers a lot of obstacles for our profession to tackle. But as long as UAP stands, these obstacles are converted into achievements. As one great author said: The reality of the building does not consist in the roof and walls, but in the space within to be lived in.

My congratulations to your Chapter on the occasion of the 2013-2014 Installation of Officers and Induction of New Members, Move on and Godspeed as we face more activities.

GILROY TAGUINOD, UAP  
National Vice President, Area A







Malugod na pagbati sa UAP SOCAL Chapter,

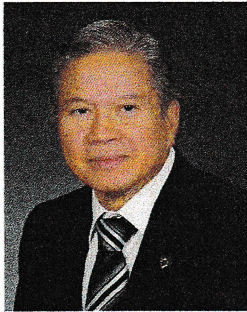

I would like to congratulate all Incoming Officers, Committee Members and new Members of your Southern California Chapter for being elected and inducted as dedicated leaders and doers in this Fiscal Year 2013-14 in your part of the State of California. I salute all members of your Chapter for the hard work. You make us all proud to be Filipino Architects. I am confident that you will hold the UAP banner high and maintain the respectability of our profession.

On behalf of the Incoming Officers or our UAPCAL Chapter No. 226, and all our formidable members, I pledge our cooperation in all your endeavor for the glory of our common good as Philippine architects in this part of the world.

Nothing is insurmountable if hearts and minds link as one. Let us all join hands and be tireless as we march onward in our quest for a better universe of harmony, prosperity and order that is paramount in the architect's utopian mind. As we are determined, we shall be triumphant.

Mabuhay ang Arkitektong Pilipino.

MARIO A. A. VELORO, cuap  
Incoming Chapter President  
UAP California Chapter No. 116  
FY 2013-2014

UNITED ARCHITECTS  OF THE PHILIPPINES  
SOUTHERN CALIFORNIA



On behalf of the Southern California Chapter of the United Architects of the Philippines the Integrated and Accredited Professional Organization of Architects, allow me to greet and welcome you to the "3<sup>rd</sup> Annual Installation of Officers and Induction of New Members" event.

Three years since our chartering, our organization continues to grow strong despite economic uncertainty and organizational difficulties -- a good indication that UAPSOCAL Chapter is here to stay .

For as long as dedicated, committed and loyal officers and members stay true and focus to the goal, objective and aspiration of the organization we will stay on course.

Congratulations to the new set of incoming officers and new members with whom I will have the honor and pleasure of serving as Chapter President. With the support of the members and the UAP National Organization, I am hopeful that with drive, determination and sense of volunteerism - much will be accomplished in the coming days.



JOVEN G. JOAQUIN, JR. UAP, LEED -AP  
Chapter President, FY 2012 - 2014

messages



## *UAP SoCal Chapter History*

After the founding of UAPCAL 116 in 2008 (based in Northern California), under the presidency of the late Arch. Eduardo Quezon, a vision to reach out to Filipino Architects based in Southern California became one of the first and foremost goals in their objectives. To realize a separate and independent chapter in Southern California would best meet the needs of our colleagues in the area. This move would prove to be beneficial for some who reside in the Southland, were holding positions of responsibilities with the Northern California chapter; thus, making them more effective in the service and pursuit of the UAP's mission and aspirations. From a small group of Filipino architects based all over Southern California, informal gatherings and meetings were held, from one place to another that attracted other Filipino architects, who came and joined in the formal establishment of the UAP-SOCAL Chapter. After a laborious process of preparing and completing the requirements, the formation of the United Architects of the Philippines Southern California Chapter was formally granted by the United Architects of the Philippines National Board of Directors on April 26, 2011, with its chartering and first ever induction of officers and members on October 16, 2011 at the Almansor Court in Alhambra, California. The UAP-SOCAL Chapter continues to grow and to reach out to ALL Filipino Architects in Southern California in an attempt to unite them in the spirit of service, fellowship and camaraderie.

### *UAP March*

United Architects of the Philippines are we  
Sworn to uphold our profession's dignity Ours is to create, to design and  
plan  
Build the Shelter for the Family of Man

As architects we build with artistry and vision  
With humble hearts so patient and with  
Dedication combining strength, utility and beauty  
Be it a simple house or complex cities

One in heart and one in soul all for one and one for all  
These Architects are the symbols of greatness Loyal to the UAP

We pledged to ourselves To serve our country  
With a fervent verve so let us all be  
Architects with Filipino soul  
To serve our country





# Oath of Officers

I, (state your name) having been elected as (state your position and chapter) do solemnly swear, to abide in all honesty and integrity to the best of my ability the duties that I shall perform under the United Architects of the Philippines, The Integrated and Accredited Professional Organization of Architects; that I shall uphold and protect the Constitution and Bylaws of the Organization; to keep faith in and put into practice the noble and good conduct of the Architect's Code of Ethics; that I shall carry out the laws and legal order of my country; to conduct myself in a manner befitting a good and true professional so as to bring honor and prestige to the organization, and advancing the interest of the profession to which we are dedicated; and that I take this pledge without mental reservation, or purpose of evasion.

SO HELP ME GOD.

## Chapter Officers



**TEOFILO R. COTANGCO**  
COMELEC



**CEZAR V. OBNIAL**  
Vice-President, Operations  
Director, Internal & External Affairs



**JOVEN G. JOAQUIN, JR.**  
Chapter President



**RAMON VICTOR C. SINGSON**  
Vice-President, Programs and  
Development

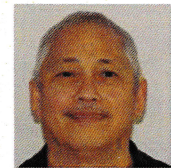

**HORACE G. ZABLAN**  
PRO



**CYNTHIA C. SALVACION**  
Chapter Secretary



**BIENVENIDO ABELLO**  
Director, Education



**RAY E. OJEDA**  
Acting Treasurer



**DOMINIC P. JUEGO**  
Director, Membership



**MA. GEMILDA M. COTANGCO**  
Chapter Auditor



**MILTON V. OGDOK**  
Director, Professional Ethics



**EMERITO D. MAULION**  
Ex - Officio



**ANTONIO C. MAMARIL, JR.**  
Director, Special Events

**Chapter Officers**



# chapter members

Nenet Sabille-Abello, uap assoc.

Bienvenido C. Abello, Jr., uap

Jose P. Alano, uap

Conrado E. Alfaro, uap

Marissa San Diego-Basilio, uap

Imelda T. Bautista, uap

Joseph Antonio B. Bautista, uap

Hipolito Bautista, uap

Eustacio Castro Jr., uap

Irma Camaganacan-Gloriani, uap

Ruben Catabas, uap assoc.

Ma. Gemilda M. Cotangco, uap

Teofilo R. Cotangco, uap

Benedicto B. De Guzman, uap

Gaspar de la Rosa, uap

Roberto R. Drucco, uap

Rojie Fantillo, uap

Edith Fuentes, uap

John Howell Gutierrez, uap

Vida R. Ilao, uap

Joven G. Joaquin, Jr., uap leed-ap

William David B. Labrado, uap

Dominic Juego, uap

Rogelio Layman, ra uap

Elmer Legaspi, uap

Antonio Mamaril, uap

Euler M. Manansala, Jr. uap

Emerito D. Maulion, uap

Florentino S. Mendoza, Jr., uap

Ramon R. Nadres, uap

Cezar V. Obnial, aia uap

Milton S. Ogdod, uap

Ray E. Ojeda, uap

Leilanie Pekson - Panyawai, uap

Norberto A. Saavedra, uap

Samuel P. Saludo, uap

Elizabeth Magaling - Pedraja, uap

Cynthia Cassanova - Salvacion, uap

Teofilo Santos, uap

Richard San Luis, uap assoc.

Mariano Sia Jr., uap

Ramon Victor C. Singson, aia uap

Christopher Tamase, uap

Anthony Tejada, uap assoc.

Guillermo Valdes, uap

Horace Zablan, uap

Ray Caballes, uap assoc.

Jocelyn Cummins, uap assoc.

Enrico P. Cinco, uap

Shannon S. Dum Dum, uap

Jun Farol, uap assoc.

Lily Bernabe-Ellenburger, uap assoc.

Cynthia A. Leif, uap

Eliseo Liwag, uap

Prudencio N. Pamatmat, uap

Manuel Rodriguez, uap

Noel A. Segovia, uap





## New Membership



**HIPOLITO S. BAUTISTA**  
Corporate Member



**MARIANO B. SIA, JR.**  
Corporate Member



**VIDA REVILLA-ILAO**  
Corporate Member



**DOMINIC P. JUEGO**  
Corporate Member



**ANTONIO C. MAMARIL, JR.**  
Corporate Member



**ANTONIO TEJADA**  
Associate Member



**GASPAR DE LA ROSA, JR.**  
Corporate Member



**MARTHA GEA L. JOAQUIN**  
Student Member

## Oath of Membership

I, (state your name) having been accepted as (state your position and chapter) do solemnly swear, to abide in all honesty and integrity to the best of my ability the duties that I shall perform under the United Architects of the Philippines, The Integrated and Accredited Professional Organization of Architects; that I shall uphold and protect the Constitution and Bylaws of the Organization; to keep faith in and put into practice the noble and good conduct of the Architect's Code of Ethics; that I shall carry out the laws and legal order of my country; to conduct myself in a manner befitting a good and true professional so as to bring honor and prestige to the organization, and advancing the interest of the profession to which we are dedicated; and that I take this pledge without mental reservation, or purpose of evasion.

SO HELP ME GOD.

**new members**





Turnover Ceremony

Picture gallery



Christmas Party

Picture gallery



39th UAP National Convention



Getty Center Tour







Chapter Turnover Ceremony



Chapter Christmas Party



39th UAP National Convention



Getty Center Tour



Picture gallery



# acknowledgements

*Thank you to the following individuals, donors and sponsors:*

Mayor Eric Garcetti, City of Los Angeles

Mayor Dave Weaver, City of Glendale  
Civil Engineer

Consul General Maria Hellen Barber de la Vega,  
Philippine Consulate Los Angeles

UAP National President Rozanno Cruz Rosal, FUAP  
RA, Int'l Assoc. AIA

UAP National VP Area A - Gilroy Taguinod, UAP

District Director A5 - Juanito Vinta, UAP

Greg Alvarez of  
CRAIG Fire Prevention Co.

Ramon and Rose Singson

TIMELY Prefinished Door Frames

LA Buffets - Anoush Galleria Grand Ballroom

Anand and Kinnari Desai of  
Glen Capri Inn and Suites, Glendale, CA

[www.dynamicbuilders.com](http://www.dynamicbuilders.com)

UAPSOCAL Event Volunteers:

Antonio C. Mamaril, Jr., Cynthia C. Salvacion; Dominic P. Juego;  
Edith M. Fuentes; Marissa Basilio; Beth M. Pedraja; Cezar V.Obnial;  
David B. Labrado; Leilanie P. Panyawai; Emerito D. Maulion; Teo and Yuli Cotangco;  
Mariano Sia, Jr., Nenet and Bien Abello; Vida R. Ilao; Joseph B. Bautista

and

to all members, guests, supporters and friends.





**TIMELY**<sup>®</sup>

**PREFINISHED  
STEEL DOOR  
FRAMES**

Timely will change your frame of mind.



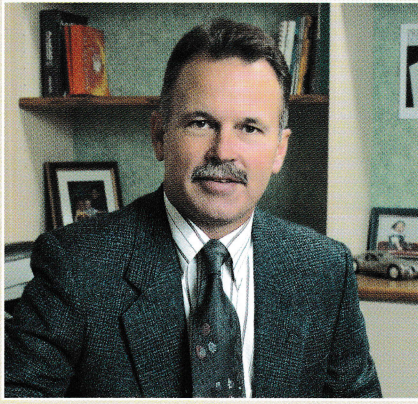

Bob Day, President

Since Timely prefinished steel door frames were introduced over 40 years ago, they have earned the trust of architects, contractors, building owners and building product distributors nationwide. Timely installations are found in many of America's most prestigious commercial, industrial and residential buildings.

Key to this success is a willingness to commit the resources necessary to adapt technological innovations and develop systems and tooling that promise superior product performance. For example, comparison tests show that our unique wall anchoring system makes Timely frames as strong as the wall, assuring door-holding capacity greater than hollow metal frames.

Timely frames are also time-savers and cost-cutters. They are faster, easier to install and our prefinished frames eliminate the added expense and inconvenience involved in jobsite painting. They represent Timely's proud tradition of quality and durability.

Our superior product performance, efficiency and economy point to an important advantage of doing business with Timely. After earning a customer's trust, we focus on keeping it—by keeping our standards high.

**TIMELY**®

*Serving Timely  
Customers...Nationwide*

*This ultra modern 80,000 square-foot manufacturing-distribution facility at our headquarters in Pacoima, California, plus an eastern distribution center in Cincinnati, Ohio, enable Timely to provide prompt, efficient deliveries to markets throughout the United States.*

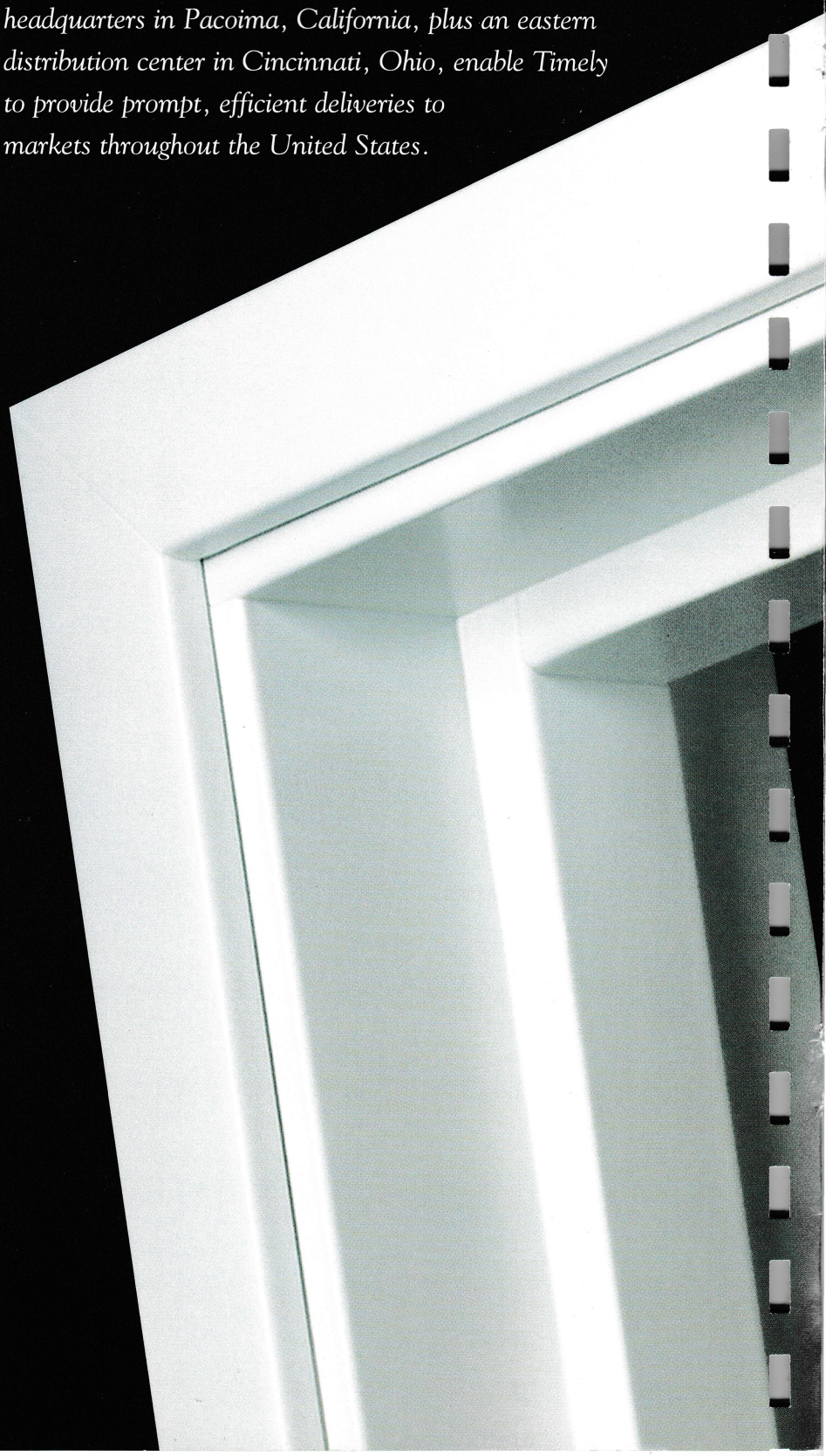



***It all starts with service.***

*Timely's steady growth, though based on product quality, is service-driven. Experienced specialists in every department display the pride and professionalism that result in efficient order fulfillment to exact specifications and prompt, on-schedule delivery. This dedication to customer satisfaction extends to an ongoing search for opportunities to design and develop manufacturing equipment in-house that will raise the bar of quality and service even higher.*

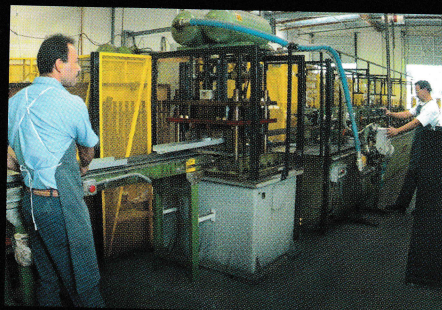
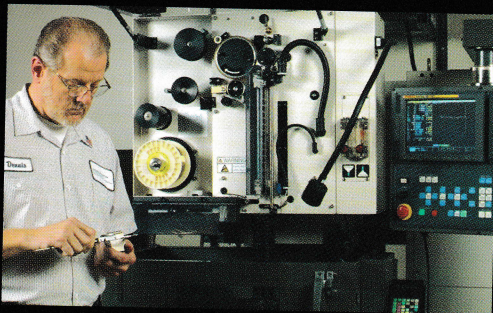
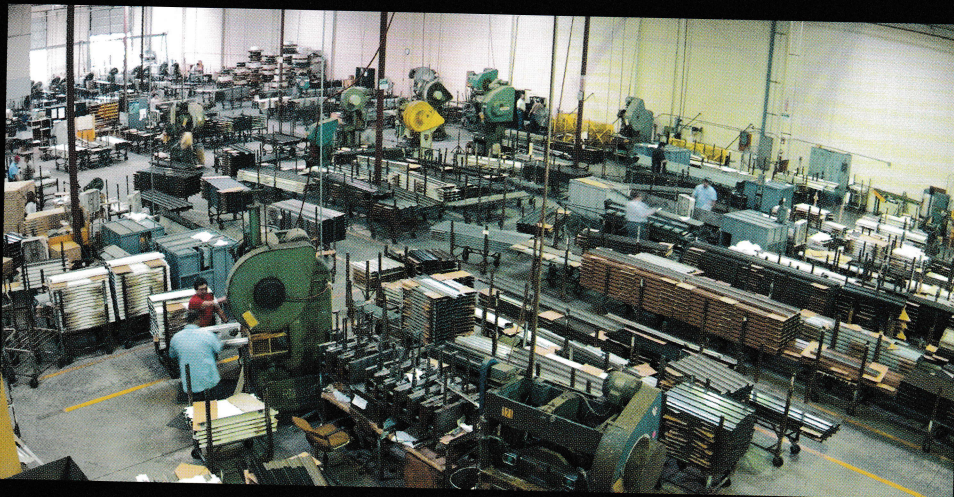

**TA-8 Standard Steel Casing**





Over 200 entry door openings and all the public areas feature Timely door frames at Belmont Village, a senior living facility in Carol Stream, Illinois. Timely sidelites were also selected. Why Timely? Timely's TA-30 Colonial steel casing in the popular Western White finish offered a warm residential look while still providing the strength, security and fire ratings required by local building codes.

## An Array of Design Options

Timely supplies frames with design flexibility to meet the most stringent commercial, industrial and residential requirements. The remarkably versatile Timely line features distinctive door frame casing profiles in steel, aluminum and PVC shown here. Plus, it offers an option to use wood trims of your choice and an unlimited selection of colors complementing doors pre-machined to Timely's specifications. Our patented sustained tension snap-lock clips permit use of our various prefinished casings. The clips hold these casings secure and flush against the wall, eliminating gaps caused by uneven surfaces, as well as creating tight miters. On the TA-8 casing, the Timely MiterGard™ offers additional open-miter protection. And Timely's unique full perimeter anchoring system furnishes far greater frame strength and integrity than hollow metal.



**TA-8 Standard Steel Casing**, widely admired for its classic profile, enhances any commercial and residential setting. Features Timely's MiterGard™

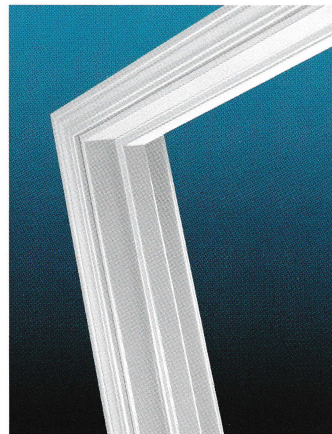
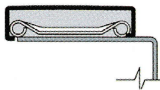

**TA-30 Colonial Steel Casing** adds that special warmth which distinguishes quality-built assisted living, hotels and motels, offices, apartments and homes. New TA-31N corner piece also featured.

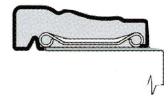

**TA-35 PVC Colonial Casing**, a delicately defined extruded PVC molding, is quickly applied to Timely's clip system. Painted or in wood grain finishes.

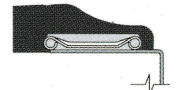

**TA-23 Aluminum Casing** displays the crisp lines of an aluminum trim, while providing the economy and strength of steel.

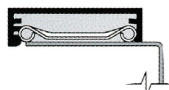

**TA-28 Aluminum Casing** is a full width aluminum casing without a reveal offering the advantages of a steel door frame.

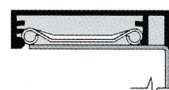

**Wood Trim**  
Even wood trims from outside suppliers can be easily attached to the basic steel frame using nails or trim head screws without the need for special millwork.





*Timely's TA-8 casings were selected for Gilmore Associates' restoration of The Continental, The Hellman and The San Fernando Buildings in Los Angeles. The TA-8 casing was favored because it assured economy, ease of installation and required fire rating -- making it a modern-day choice for use in historic high-rise structures. The frames were prefinished in Timely's Alumatonē™, a color match for clear anodized aluminum.*

## Color Coordination Offers Design Flexibility

Successful color coordination is easily achieved with Timely's basic selection of six stocking designer colors and 29 custom colors as well as **prime**. Timely can also match any color upon request. And quality is assured, because all colors are applied in coil form with a durable baked-on polyester finish. Powder coat finishes are available for special applications.

An important advantage of Timely's prefinished frames is a saving in jobsite painting costs of \$25 to \$50 per opening—plus the guarantee of color uniformity throughout the installation. Prefinishing also permits installation after walls are finished to avoid costly delays and wall damage. Spills, inadequate prepping, poor workmanship and touch-ups are problems of the past. So are the possible environmental problems. Timely frames are painted under controlled conditions to protect air, water and land from pollution.



Timely frames can also be protected against environmental hazards such as rust and corrosion from chemicals and high humidity. Just specify electro-galvanized frames.

## Optimum Safety-Engineering



Timely prefinished frames are engineered to deliver a 90-minute positive pressure fire rating for wood/steel stud drywall or masonry wall construction. Frames have undergone testing by Warnock Hersey International. They are labeled fire rated Category "A" door or Category "B" door with approved Category "G" edge-sealing system.

## MiterGard™ -The Open Miter Fighter

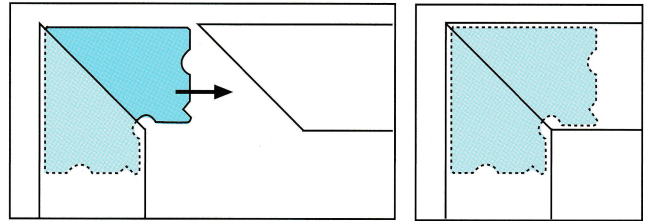

MiterGard™ is factory-attached to vertical casing. Exposed section slides securely into header casing.

MiterGard produces tight miters every time—with this built-in corner piece. The reason: its "L" shaped component is attached to the vertical door frame casings at the Timely factory. Pre-assembly makes it an integral part of the casing and, therefore, stronger and more accurate. MiterGard's exposed sections slide into the header casing for a precise fit. When installed according to factory instructions, it guards against errors that cause open miters and solves future open miter problems resulting from building movement or constant door operation. Designed exclusively for Timely's Model TA-8 casing, MiterGard reduces field labor costs through less handling.

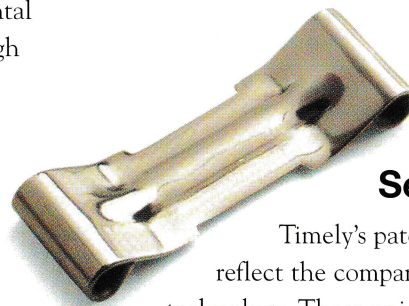

## Innovative Casing Clip Sets The Standard

Timely's patented casing attachment clips reflect the company's leadership in steel door frame technology. These unique clips are designed to compensate for surface distortion, eliminating ugly gaps. Their "snap-lock" feature makes casings removable, permitting a change of color combinations if desired. For utmost strength, clips are formed burr-free from "mild steel." They are then case hardened, carbonized and zinc coated for rust resistance and lubrication.





*Liberty Square Condos, developed by Hartz Construction in Chicago's western suburb of Lombard, Illinois, chose Timely's fire-rated frames for their flexibility. The condo units' door frames feature 3 1/2" wood colonial casings, while Timely's TA-8 steel casings were used in the stairwells. Timely "A" Series Adjustable Frames were specified to allow for various wall sizes and applications throughout the buildings. And, they were shipped pre-hung with six panel fire-rated metal doors -both are impossible tasks for hollow metal frames.*

## High Performance Features

The total opening concept from Timely incorporates unique features, adding up to economical, attractive and stronger door installations.

- 1. Casing Corner Connector** holds mitered corners tight. MiterGard™ featured on TA-8 casings.
- 2. Adjustable Strike** permits full 1/4" adjustment, assures positive, rattle-free fit.
- 3. Full Width Aligning Tabs** correctly align uprights and header.
- 4. Pre-punched Fastener Holes** mean easier fastening.
- 5. Individually Attached Casing Clips** assure a snug casing fit that follows the irregularity of walls.
- 6. Alignment Slot** oval punch-outs allow visual check of frame spacing and adjustment during installation.
- 7. 14 Ga. Hinge Reinforcement Plates** are factory attached to give hinge strength of a 12 ga. frame.
- 8. TA-10, TA-12, TA-25 Reinforcement Brackets** are for door guards, closers and other hardware applications.

## Adjustable Frame

Timely's slide guide system allows its Adjustable Frame to accommodate any wall thickness from 3 3/4" to 9 1/8" with only 3 closure strips. It can be prehung or used as a standard drywall frame. Available in Browntone, Western White or Black powder coat finish, the adjustable frame is used with 1 3/4" doors only.

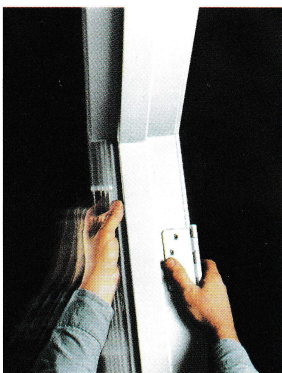

## Matchless Construction Versatility

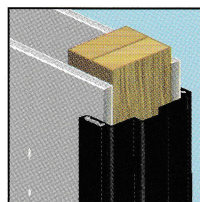

Timely prefinished door frames can be attached to virtually any construction material including wood stud and drywall (as illustrated here) plus:

- Wood Stud/Stucco/Drywall
- Wood Stud/Brick/Drywall
- Steel Stud & Drywall
- Masonry/Sub-buck
- (Adjustable Frame) Wood Stud/Drywall/Sound Board
- Traditional Wood Stud/Drywall

In most common wall construction, the job involves sleeving the frame over the wall, hanging the premachined door, fastening the frame and snapping on the casing. In addition to fast positioning, Timely frames provide accurate fit.

## Economy Plus Easy Installation

Costly jobsite labor is avoided when Timely prefinished steel frames are used with premachined doors. Only one-man is required for the frame installation which is usually completed in less than 15 minutes.

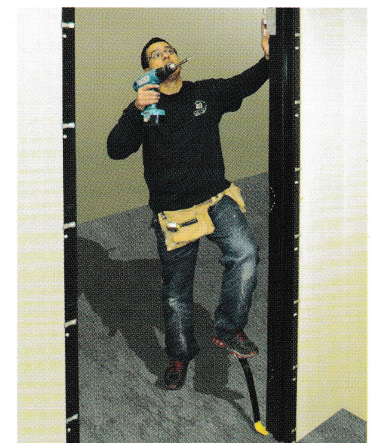





At the La Quinta Hotel in Stockbridge, Georgia, more than 200 door openings and over 20 interior windows were specified for Timely steel frames. The reasons: Prepainted finishes permitted faster, easier installations. And, Timely Series A adjustable frames saved installation time by accommodating final wall size changes.

## Framing Specifications

Walls and floors may be finished before installing doors and frames. Measure height from finished, not rough floor. A minimum 2" stub wall is required on both sides of the rough opening for solid anchoring. For sub-buck applications (masonry, tilt-up concrete) rough opening is door width plus 4", door height plus 2 1/4".

### Rough Opening Dimensions

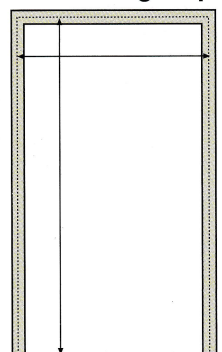

**Door**  
Nominal Door Width + 1 1/4"  
Jamb Height + 1"

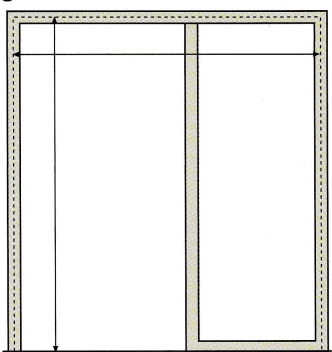

**Door with Sidelite**  
Nominal Door Width + Sidelite + 2" for each  
Mullion + 1 1/4"  
Jamb Height + 1"

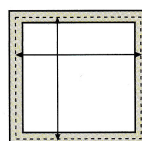

**Borrowed Lite**  
Width = Rabbet to Rabbet + 1 1/4"  
Height = Rabbet to Rabbet + 1 1/4"  
Note: Actual glass size is smaller.  
Always measure frame before ordering glass

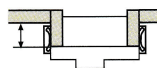

2" minimum stub wall required

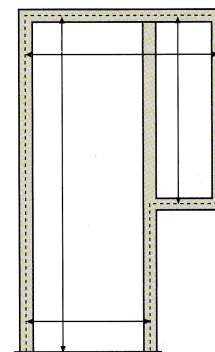

**Door and Partial Sidelite**  
UPPER: Nominal Door Width + Sidelite + 2" for each Mullion + 1 1/4"  
LOWER: Nominal Door Width + 1 1/4" Jamb Height + 1"  
Sidelite Height: Rabbet to Rabbet + 1 1/4"

## Code Acceptability, Certification

### SINGLE SWING FRAMES

20 MIN. \*  
45 MIN. "C" LABEL  
90 MIN. "B" LABEL

MAXIMUM OPENING SIZE		WALL SIZE		FRAME SERIES
WIDTH	HEIGHT	MIN	MAX	
4/0	10/0	3 3/8"	13"	C
4/0	9/0	3 3/8"	13"	S,C,M,A,** E
4/0	9/0	3 3/8"	13"	S,C,M,A,** E

\*Negative pressure only  
\*\* Maximum opening 4/0 x 8/0

### FULL BOUND WITH DOOR

45 MIN. "C" LABEL  
90 MIN. "B" LABEL

MAXIMUM OPENING SIZE		WALL SIZE		FRAME SERIES
WIDTH	HEIGHT	MIN	MAX	
4/0	5/0	3 3/4"	13"	S,C,E
4/0	5/0	3 3/4"	13"	C

### PAIR FRAMES

20 MIN.  
45 MIN. "C" LABEL  
90 MIN. "B" LABEL

MAXIMUM OPENING SIZE		WALL SIZE		FRAME SERIES
WIDTH	HEIGHT	MIN	MAX	
For 20 Min. Pair. use C Label Requirements				
8/0	9/0	3 3/8"	13"	S,M,C,E
8/0	9/0	3 3/8"	13"	S,M,C,E

### ADJUSTABLE PAIR FRAMES

45 MIN. "C" LABEL  
90 MIN. "B" LABEL

MAXIMUM OPENING SIZE		WALL SIZE		FRAME SERIES
WIDTH	HEIGHT	MIN	MAX	
8/0	8/0	3 3/4"	9 1/8"	A
8/0	8/0	3 3/4"	9 1/8"	A

### GENERAL INFORMATION

All ratings are usable for steel stud, wood stud, or masonry construction (steel sub-buck).

When using a wood sub-buck in place of Timely's metal insert for masonry construction, drywall must be used on both sides.

Single frames not prepared for strikes must use TA-12 rim panic strike reinforcement.

Reinforcements are required when using door closers to maintain fire ratings.

Fire ratings not approved for 1 3/8" frames.

All ratings approved for category "A" and "B" doors with category "G" edge sealing.

Solid brass not rated.



### SIDELITE, BORROWED LITE AND GLAZED TRANSOMS "S" or "C" GAUGE.

Wood Casing permitted on sidelites or borrowed lites for 20 Min. without vertical or horizontal mullions in glass area.

GLASS STOP SIZE	RATING	MAX ASSEMBLY SIZE 10'-1" W X 10'-1" H		WALL SIZE		MAX GLASS AREA
		WIDTH	HEIGHT	MIN	MAX	
1/2	45 MIN	24"	107"	3 3/8"	13"	*2568 SQ IN
**1/2	45 MIN	36"	54"	3 3/8"	13"	1296 SQ IN
NO STOP						
3/4	45 MIN	36"	54"	3 3/8"	13"	1296 SQ IN
GLASS STOP SIZE	RATING	MAX ASSEMBLY SIZE		MULLIONS NOT PERMITTED WALL SIZE		MAX GLASS AREA
		WIDTH	HEIGHT	MIN	MAX	
1/2	20 MIN	36"	36"	3 3/8"	13"	1296 SQ IN
**1/2	60 MIN†	36"	36"	3 3/8"	13"	1296 SQ IN

†Minutes negative pressure

Do not exceed maximum assembly size.

\*Most building codes limit glass area to 1,296 sq. in. Do not exceed 1,296 sq. in. without verifying with local code authorities prior to specifying or ordering.

\*\*Must be caulked using 100% Pure Silicone Sealant.

\*\*\*Must use Firelite® glazing and install in a 5/8" wide glazing recess with 100% Pure Silicone Sealant.

All ratings cover positive or Negative Pressure except where indicated.

## Timely Sidelites and Borrowed Lites

The beauty and economy of the Timely frame sidelite and borrowed lite system are available to meet most glazed opening requirements. And because they're prefinished, they can be applied over finished walls. As a result, costly time delays and special fabrication are avoided.





*Prepainted finishes and a positive pressure fire rating sold the builders of the ISC office/warehouse on Timely steel door frames. The strength and durability of Timely frames were important features for the high-abuse doorways between offices and warehouse. Easy installation was another plus for Timely. The 20,000 sq. ft. metal building is in the Richmond, Virginia area.*

**Keep up with new products, innovations, applications  
and specifications plus the latest CAD/CAM drawings at:**

**WWW.TIMELYFRAMES.COM**

### **TIMELY INDUSTRIES LIMITED WARRANTY**

S.D.S. Industries, Inc., a California Corporation D.B.A. Timely Industries (hereafter called Timely), warrants to the original consumer purchaser that its Timely Prefinished Steel Door Frame when utilized for interior frame use, will be free from defects in material and workmanship for a period of one year from the date of purchase.

This warranty is applicable only when the products covered by it:

- 1) have been installed in accordance with the recommended written installation instructions of Timely Industries and with established building practices.
- 2) have been accorded treatment which is considered good practice in the Building Industry regarding storage and maintenance.
- 3) have been subjected only to normal use because Timely Industries cannot control the manner in which its products are handled after leaving its premises. This warranty does not apply to the finish or accessories of any product and shall not apply to any frame exposed to a corrosive or humid environment.

ANY AND ALL IMPLIED WARRANTIES APPLICABLE HERETO ARE LIMITED TO ONE

YEAR FROM THE DATE OF PURCHASE. Some states do not allow limitations on how long an implied warranty lasts, so the above time limitation may not apply to you. In the event the original consumer purchaser of any Timely Industries Prefinished Steel Door Frame believes that the frame or any parts thereof covered by this warranty are defective, a letter outlining the alleged defect should be sent postage prepaid to the following address:

TIMELY INDUSTRIES, 10241 NORRIS AVENUE, PACOIMA, CA 91331

Any Timely Prefinished Steel Door Frame or any parts thereof covered by this warranty which, upon inspection by an authorized Representative of Timely Industries are found by said Representative to be defective, will at the option of Timely Industries either repair, replace, or refund the purchase price of the frame or component part. Liability is limited to repair, replacement, or refund and does not include labor, installation cost, or indirect or consequential damages of any nature. Some states do not allow the exclusion or limitation of incidental or consequential damages, so the above limitation or exclusion set forth in this paragraph may not apply to you.

### **TECHNICAL SUPPORT**

Timely provides the services of a tool and die shop, a knowledgeable sales force and stocking distributors to satisfy your needs on time and at competitive prices.

**TIMELY**  
**PREFINISHED STEEL DOOR FRAMES**  
A DIVISION OF S.D.S. INDUSTRIES, INC.





**TIMELY**



MADE IN THE USA SINCE 1971

**WHAT'S NEW  
AT TIMELY**



# WHAT'S NEW AT TIMELY

WE ARE CELEBRATING 40 YEARS OF BUSINESS

# TIMELY



MADE IN THE USA SINCE 1971

## CELEBRATING 40 YEARS

Timely has been the industry leader in pioneering the prefinished opening concept. As markets have opened, numerous innovations have been introduced that have changed the way door openings are perceived. Timely's message of superior performance, design flexibility and lower cost has made this the product of choice for architects, contractors, developers, and installers. For over 40 years we have continued to innovate and adapt resulting in reduced costs for end users and profitable results for our dealers.

## OUR NEW TIMELY DOUBLE EGRESS FRAME

Now, with the introduction of the new Timely Double Egress (DE) frame, your project requirements for double egress openings can be met with a frame that matches the rest of the frames on the project. Instead of selecting a different type of frame for cross corridor fire separation or traffic control, the design professional has the opportunity to use Timely on all the interior openings of the project.

Header-Double Egress

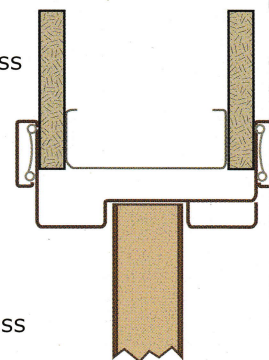

Upright-Double Egress

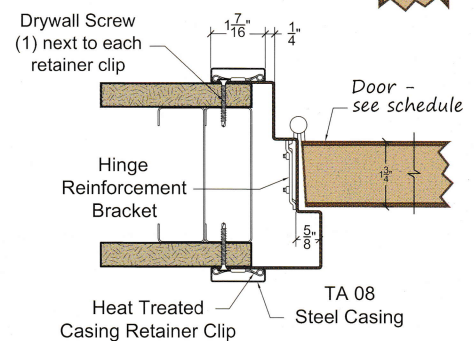



# OUR NEW PRODUCTS

## OUR NEW TIMELY INVERTED STOP POCKET JAMB

With traditional pocket trim, the door closes against a flat surface. With the new inverted stop option, the door closes into a recess on the jamb creating the privacy often desired for rooms using pocket door applications. The jamb can also be prepared for the lock strike making the opening both private and secure.

Inverted Stop Pocket Jamb

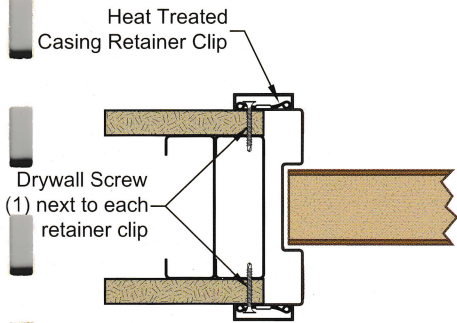

## WE NOW OFFER CUSTOM HARDWARE PREPS

Timely has successfully established a process to cut, weld, and post-paint frames requiring non standard hardware preparations. Now using this new process, we are able to prepare frames for most types of hardware including:

- Concealed Vertical Rod Exit Device strikes (Von Duprin, Dorma, Sargent, Falcon)
- Electronic Power Transfers - EPT (Von Duprin, ABH)
- Overhead Concealed Stops and holders (ABH, Glynn-Johnson, Rixson, Sargent)
- European Mortise Lock Strikes
- Overhead Concealed Closers (Concealed in door) - (Dorma)
- Center Hung Pivot sets (ABH, Ives, Stanley, McKinney, Rixson)
- Rescue hardware - double lipped strikes and emergency releases
- Recessed Magnetic contacts and switches

**LEARN MORE:** TIMELY 10241 Norris Avenue Pacoima, CA 91331  
Ph 818.492.3500 or 800.247.6242

E-mail [sales@TimelyFrames.com](mailto:sales@TimelyFrames.com) | <http://www.TimelyFrames.com>

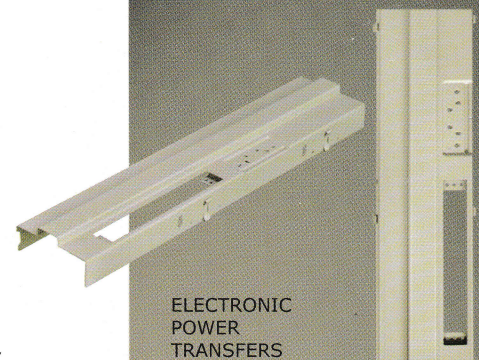



# NEW PRODUCTS — AVAILABLE NOW continued

## ASYMMETRICAL BORROWED LIGHTS

With increased demand for natural lighting of interior spaces, design requirements for borrowed lights are changing. Recently, we introduced a borrowed light with a sloped sill. With this new ability to create corner connections at a multitude of angles, we are no longer limited to traditional square or rectangular borrowed lights. Designers can incorporate Timely asymmetrical borrowed lights in their design creating the exact look they desire.

## EXTENDED SILL

For many years, other frame manufacturers have offered high sill faces on sidelight frames. A sill face of up to 12" high is now available from Timely to accommodate this need. The high sill makes it much easier to keep the sidelight glass clean and the flat surface requires ADA requirements.



## PLANS IN THE WORKS TO START THE ROLLOUT OF OUR NEW TIMELY WEBSITE PROTOTYPE

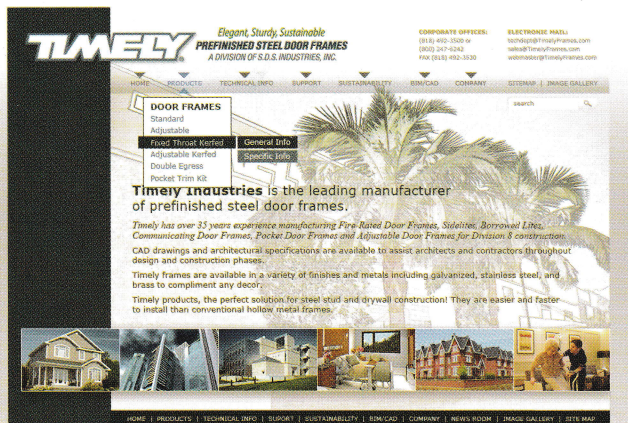

The plan: To look to our customers, architects and others concerned to review the interface/navigation and content of this prototype section of the new web site. We want your comments, thoughts, and suggestions. Please give it all to us; we want this new website to be of a real service to you.



Manufactured By: **Timely Industries, Inc.**

10241 Norris Avenue Pacoima, CA 91331  
Ph 818.492.3500 or 800.247.6242  
Fx 818.492.3530

E-mail [sales@TimelyFrames.com](mailto:sales@TimelyFrames.com)  
<http://www.TimelyFrames.com>





**PREFINISHED STEEL DOOR FRAMES**

A DIVISION OF S.D.S. INDUSTRIES, INC.

CALIFORNIA OFFICE: (818) 492-3500 • FAX (818) 492-3530

# Finish Options

## Timely Finishes

*\*Available for adjustable frames in powder coat. †Available prefinished for fixed Throat Kerf frames.*

STANDARD PRICE

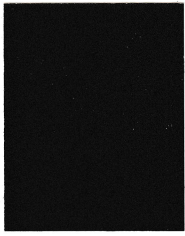

BROWNTONE (SC101)\*†

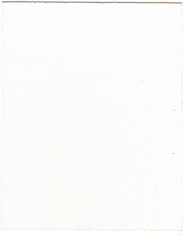

WESTERN WHITE (SC107)\*†



PRIMER EG (SC109)\*†

ADD 52¢ Per Foot



AUTUMN BROWN (SC102)\*



BLACK (SC103)\*†



STONE GRAY (SC106)\*



ALUMATONE (SC108)\*

## Pre-Matched Custom Finishes

*Custom color matching also available.  
Submit color chip. Consult factory for pricing.*



WHITE WHITE (CC301)

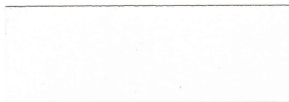

WHITE SMOKE (CC302)

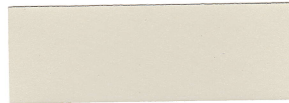

NAVAJO WHITE (CC104)

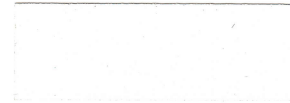

WINTER WHITE (CC105)



CHARCOAL (CC401)

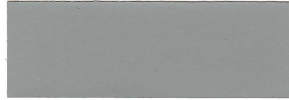

CAPE COD GRAY (CC402)

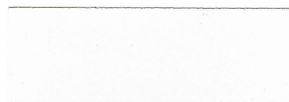

BONE CHINA (CC303)

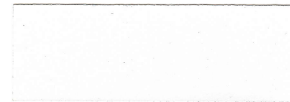

DESIGNER WHITE (CC304)

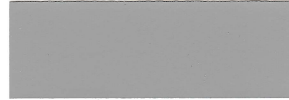

NEUTRAL GRAY (CC403)

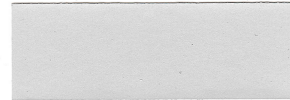

NICKEL (CC404)



DRIFTWOOD (CC501)



SANDY BEACH (CC502)

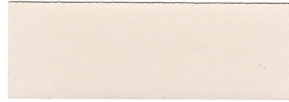

CAMEO BEIGE (CC503)



COZY PEACH (CC504)



BROWN SUGAR (CC601)



COCOA (CC602)



DOESKIN (CC603)



HARVEST MOON (CC604)

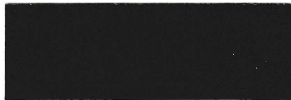

CORDOVAN (CC701)



RUBY RED (CC702)



ROSEDUST (CC703)

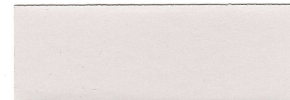

MAUVE MIST (CC704)



PACIFIC BLUE (CC801)



TWILIGHT (CC802)

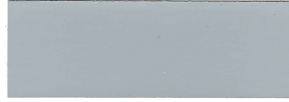

COUNTRY BLUE (CC803)



JADE (CC901)



KENTUCKY GRASS (CC902)



MIAMI WATERS (CC903)



MALIBU GREEN (CC904)



BLACK NICKEL (CC905)

## Elite Series



BRIGHT SOLID BRASS (ES201)  
BRIGHT PLATED BRASS (ES202)

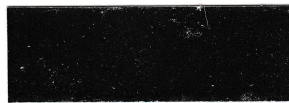

STAINLESS STEEL  
430 BRIGHT (ES204)



304 #4 BRUSHED STAINLESS  
STEEL (ES206)

For complete technical information, contact your Timely distributor or our Marketing Service Department. Colors shown may vary slightly. Colors & price subject to change. Color chips available upon request, all finishes are semi-gloss unless otherwise specified. Touch-up paint available upon request, colors may vary slightly.



